

PIŁY TARCZOWE Z WĘGLIKAMI SPIEKANYMI DO CIĘCIA WZDŁUŻNEGO DREWNA LITEGO TYPU O GEOMETRII OSTRZA GM, 2GS I KĄCIE NATARCIA 20°







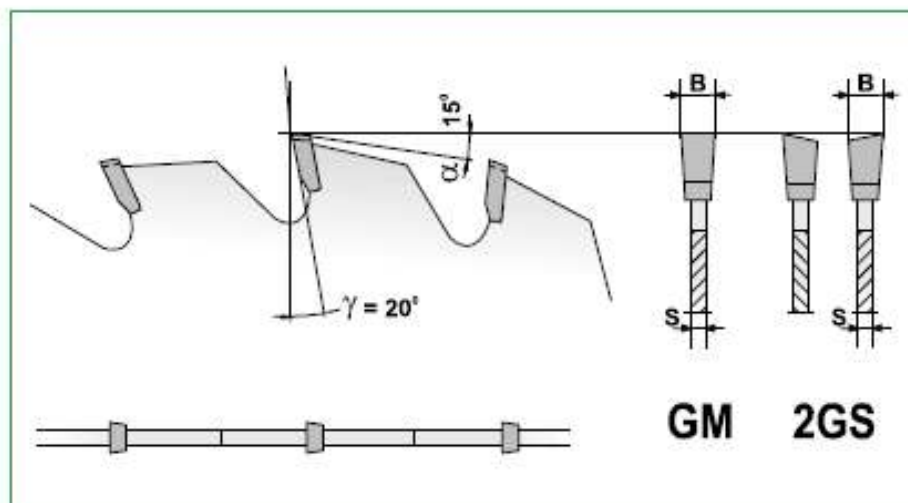

Profesjonalne piły typu  wyposażone są w dysk gwarantujący dużą sztywność w trudnych warunkach pracy, charakterystycznych dla wysokowydajnych wielopił. Odpowiednio usytuowane w dysku piły noże zgarniające umożliwiają szybkie usuwanie wiórów z przestrzeni ciętej.

Przeznaczenie:

- piły przeznaczone do cięcia wzdłużnego drewna świeżego, miękkiego i twardego na wielopiłach jedno lub dwuwałowych
- jednym z warunków prawidłowej pracy pił jest odpowiedni odciąg wiórów

PIŁY TYPU Z DWOMA NOŻAMI ZGARNIAJĄCYMI









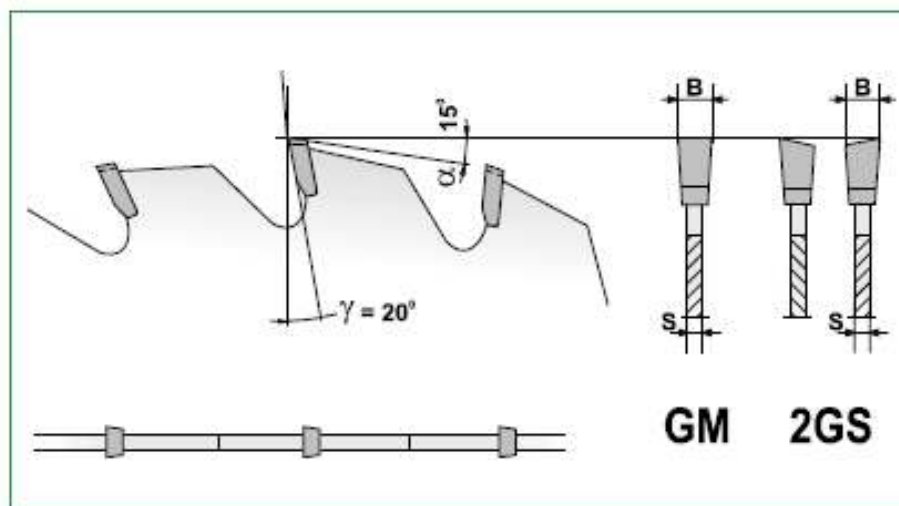

indeks						Geometria			
	mm	mm	mm	mm			il(axh)	szt.	
○ PS110-0200-0003	200	32	3,2	2,0	18+2	2GS	-	1	5900855052986
○ PS110-0200-0001	200	40	3,2	2,0	18+2	2GS	-	1	5900855048422
○ PS110-0200-0002	200	50	2,0	1,4	18+2	2GS	-	1	5900855048675
○ PS110-0250-0007	250	50	3,2	2,0	24+2	2GS	-	1	5900855027069
○ PS110-0250-0002	250	60	3,2	2,2	20+2	2GS	4(20x6)	1	5900855027014
○ PS110-0250-0014	250	60	4,0	2,5	20+2	2GS	4(16x7)	1	5900855044110
○ PS110-0250-0020	250	70	3,2	2,0	16+2	2GS	4(20x6)	1	5900855058230
● PS110-0250-0016	250	70	3,2	2,2	16+2	GM	-	1	5900855048101
● PS110-0250-0004	250	70	3,2	2,0	24+2	2GS	4(20x6)	1	5900855027038
○ PS110-0250-0015	250	80	2,8	2,0	16+2	2GS	-	1	5900855046244
○ PS110-0250-0006	250	80	2,8	2,0	20+2	2GS	4(14x6,5)	1	5900855027052
○ PS110-0250-0003	250	80	3,2	2,2	24+2	2GS	4(20x5)	1	5900855027021
○ PS110-0270-0002	270	80	2,8	2,0	20+2	2GS	4(14x6,5)	1	5900855055550
○ PS110-0300-0014	300	65	3,2	2,2	20+2	2GS	2(20x6)	1	5900855048927
○ PS110-0300-0011	300	70	3,2	2,2	24+2	2GS	4(14x6)	1	5900855048033
○ PS110-0300-0018	300	70	3,5	2,5	24+2	2GS	4(20x6)	1	5900855055635
● PS110-0300-0001	300	70	3,6	2,5	24+2	2GS	4(20x6)	1	5900855027151
● PS110-0300-0005	300	80	3,6	2,5	24+2	2GS	4(20x6)	1	5900855027199
○ PS110-0315-0002	315	90	3,2	2,2	20+2	2GS	2(20x6)	1	5900855048934
○ PS110-0350-0014	350	50	3,6	2,5	24+2	2GS	4(20x6)	1	5900855048996
● PS110-0350-0003	350	60	3,6	2,5	24+2	2GS	4(20x6)	1	5900855027274
● PS110-0350-0001	350	70	3,6	2,5	24+2	2GS	4(20x6)	1	5900855027250
○ PS110-0350-0016	350	80	3,6	2,5	18+2	2GS	4(12x4)	1	5900855057226
○ PS110-0350-0002	350	80	3,6	2,5	24+2	2GS	4(20x6)	1	5900855027267
○ PS110-0350-0007	350	80	3,6	2,5	24+2	2GS	4(13x5)	1	5900855027311
○ PS110-0350-0015	350	85	3,6	2,5	24+2	2GS	4(20x6)	1	5900855056274
● PS110-0350-0004	350	90	3,6	2,5	24+2	2GS	4(20x6)	1	5900855027281
○ PS110-0400-0003	400	50	4,0	2,8	32+2	2GS	4(13x5)	1	5900855027380

Legenda: a – szerokość rowka h – wysokość rowka ● – na stanie magazynowym ○ – na zamówienie

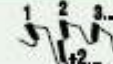
PIŁY TYPU  Z CZTEROMA NOŻAMI ZGARNIAJĄCYMI









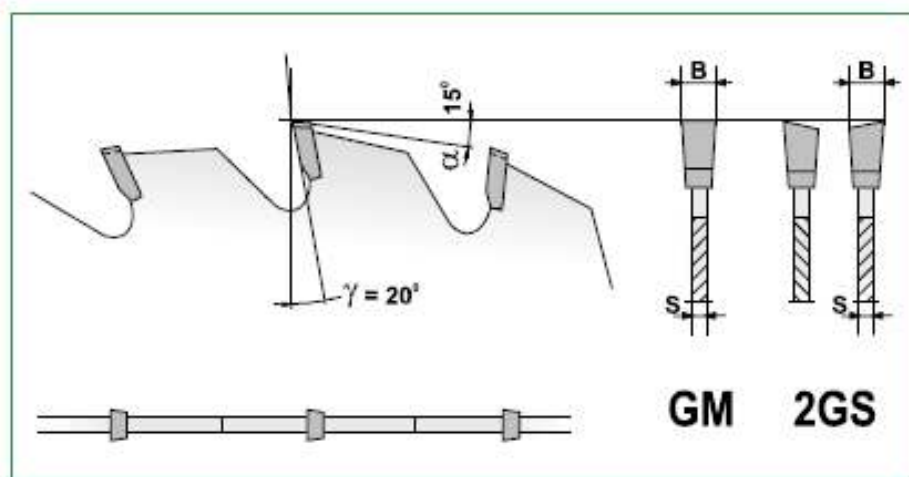

indeks						Geometria			
	mm	mm	mm	mm			il(axh)	szt.	
○ PS120-0300-0024	300	50	3,6	2,5	18+4	2GS	-	1	5900855055338
○ PS120-0300-0023	300	70	3,2	2,2	12+4	2GS	4(20x5)	1	5900855055079
● PS120-0300-0001	300	70	3,2	2,2	16+4	2GS	4(20x5)	1	5900855027458
○ PS120-0300-0008	300	70	3,2	2,2	16+4	GM	4(20x5)	1	5900855027526
○ PS120-0300-0019	300	70	3,6	2,5	16+4	GM	4(21x6)	1	5900855051149
● PS120-0300-0004	300	70	3,6	2,5	18+4	2GS	4(20x6)	1	5900855027489
● PS120-0300-0015	300	70	3,6	2,5	18+4	GM	4(20x6)	1	5900855048002
○ PS120-0300-0018	300	80	3,2	2,2	18+4	2GS	4(20x6)	1	5900855049986
○ PS120-0300-0021	300	70	3,4	2,2	16+4	2GS	4(20x8)	1	5900855054034
○ PS120-0300-0027	300	80	3,6	2,5	16+4	GM	4(18x7)	1	5900855057097
○ PS120-0300-0002	300	80	5,0	3,5	20+4	2GS	4(18x7)	1	5900855027465
● PS120-0315-0002	315	70	3,6	2,5	18+4	2GS	4(20x6)	1	5900855027595
○ PS120-0350-0041	350	50	4,0	2,5	18+4	2GS	1(20x6)	1	5900855058636
● PS120-0450-0006	450	70	4,4	3,2	24+4	2GS	4(20x6)	1	5900855028219
○ PS120-0450-0023	450	70	4,8	3,2	18+4	2GS	1(20x6)	1	5900855058605
○ PS120-0450-0010	450	70	4,8	3,4	24+4	2GS	4(20x10)	1	5900855028257
● PS120-0450-0017	450	70	5,0	3,5	18+4	2GS	4(21x6)	1	5900855051125
○ PS120-0450-0021	450	70	5,0	3,5	18+4	2GS	4(20x6)	1	5900855055642
○ PS120-0500-0002	500	50	4,8	3,4	36+4	2GS	4(8x4)	1	5900855028318
● PS120-0500-0005	500	60	4,2	3,0	18+4	2GS	-	1	5900855028349
○ PS120-0500-0001	500	70	5,0	3,6	24+4	2GS	4(20x10)	1	5900855028301

Legenda: a – szerokość rowka h – wysokość rowka ● – na stanie magazynowym ○ – na zamówienie

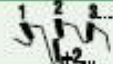
PIŁY TYPU  Z SZEŚCIOMA NOŻAMI ZGARNIAJĄCYMI



indeks						Geometria			
	mm	mm	mm	mm			il(axh)	szt.	
● PS130-0450-0011	450	50	4,4	3,2	18+6	2GS	-	1	5900855055321
● PS130-0450-0006	450	70	4,4	3,2	18+6	GM	4(20x6)	1	5900855044738
○ PS130-0450-0004	450	70	4,4	3,0	24+6	2GS	4(20x6)	1	5900855028400
● PS130-0450-0001	450	70	5,0	3,4	14+6	2GS	4(20x6)	1	5900855028370
● PS130-0450-0005	450	80	4,4	3,0	24+6	2GS	4(20x6)	1	5900855028417
○ PS130-0500-0008	500	50	5,0	3,4	18+6	2GS	4(20x6)	1	5900855043427
○ PS130-0500-0009	500	60	5,0	3,4	18+6	2GS	4(20x6)	1	5900855050838
● PS130-0500-0001	500	70	5,0	3,4	18+6	2GS	4(20x6)	1	5900855028424
● PS130-0500-0010	500	70	5,5	3,5	18+6	GM	4(20x6)	1	5900855048484
○ PS130-0500-0012	500	70	6,0	4,5	18+6	2GS	4(21x6)	1	5900855051118
○ PS130-0500-0013	500	110	5,0	3,4	20+6	2GS	2(17x10)	1	5900855052238
○ PS130-0550-0002	550	70	6,0	4,8	18+6	GM	4(20x6)	1	5900855053976

Legenda: a – szerokość rowka h – wysokość rowka ● – na stanie magazynowym ○ – na zamówienie